

DIGI - PANEL

Introduction

Digi-Panel is a quality range of Aluminium Composite Panel that comes in various specifications. All sheets are manufactured with an optimized special PE coating designed specifically for superior ink adhesion when printed with UV Cured ink – testing is advised. Digi-Panel Premium has a 0.30mm thick Aluminium skin that can be routed one side then bent into desired shapes to suit 2D & 3D applications, Digi-Panel Sign with a 0.21mm Aluminium skin is a perfect all round product for flat indoor & outdoor signage and Digi-Panel Lite with a 0.15mm Aluminium skin is a perfect economical product where cost saving is required. Available in a full range of sizes, thicknesses and finishes Australia wide Digi-Panel is an ideal product to have on hand for every industrial print house and sign manufacturer.



Product Range

All Digi-Panel products have an optimised polyester coating, designed specifically for UV cured printing.

DIGI - PANEL SIGN

- Signage grade
- 0.21mm Aluminium skin
- UV cured printable
- Available in wide range of sizes
- UV resistant



Available Nationally



- Melbourne
- Sydney
- Brisbane
- Perth
- Adelaide
- Darwin

DIGI - PANEL

Finishing Techniques

● Sawing



PREMIUM SIGN LITE

● Shearing

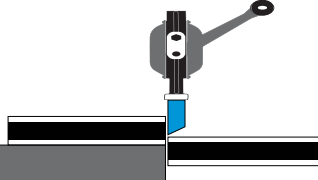

PREMIUM

● Bending

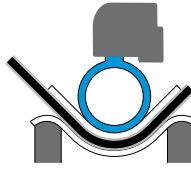

PREMIUM

● Riveting



PREMIUM SIGN LITE

● Fixing

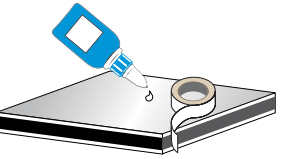

PREMIUM SIGN LITE

● Drilling

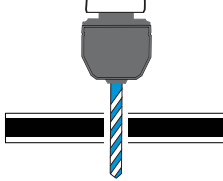

PREMIUM SIGN LITE

● Routercut Lettering

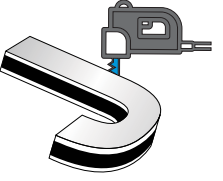

PREMIUM SIGN LITE

● Painting



PREMIUM SIGN LITE

● Grooving

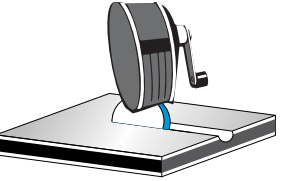

PREMIUM

● UV Printing
satin PE side only

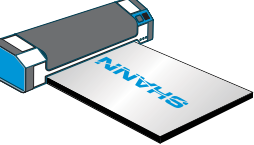

PREMIUM SIGN LITE

● Routing

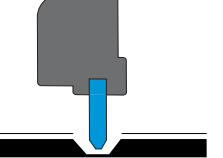

PREMIUM

● Mounting

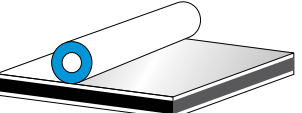

PREMIUM SIGN LITE

Info

Digi-Panel is an extremely versatile product that can be finished in many different ways to suit a vast range of applications. Whether your finished application is 2D or 3D, there is a Digi-Panel product right for the job.

Digi-Panel Sign is just right for your standard finishing techniques such as drilling, sawing and riveting.

Please refer to the various diagrams of techniques on this page relevant to finishing the Digi-Panel product.

■ Diagrams are a guide only. Testing is recommended.

Product Specifications

Shann Australia | Digi-Panel Specification testing

Dimensional tolerances	Test	Test value
Length (mm)	±2mm	1mm
Width (mm)	±2mm	0mm
Thickness (mm)	±0.2mm	-0.04mm – +0.02mm
Squareness (mm)	≤5mm	1mm
Edge Straightness (mm)	≤1mm/m	0.2mm/m
Warp Resistance	≤5mm/m	5.0mm/m

Surface properties	Test	Test value
Coating Thickness	Min. >16 micron	Average 28 micron
Gloss Tolerance	<10	2.2
Pencil Hardness	>HB	2H
Coating Flexibility	<3T	OT
Coating Adhesive	Not Lower than class 1	Class 0
Impact Resistance	50Kg – CM / No Crack	50Kg – CM / No Crack
Boiling Water Resistance	Boil for 2 Hours without change	No Change
Acid Resistance	Immerse surface in 20% HC1 for 24 hours without change	No Change
Alkaline Resistance	Immerse surface in 20% NaOH for 24 hours without change	No Change
Oil Resistance	Immerse surface in 20% engine oil for 24 hours without change	No Change
Solvent Resistance	Wipe 100 times with solvent without change	No Change
Scrub Resistance	>10 000 times without Change	No Change

Physical properties	Test	Test value
Bending Strength	>60mPa	78MPa
Bending elastic modulus	>1.5 x 10 ⁴ Mpa	2.1 x 10 ⁴ MPa
Penetration resistance	>5.0kN	5.0kN
Shearing Strength	>20.0MPa	21.3MPa
180° Peel Strength	>5.0 Newton /.mm	6.5 Newton / mm
Thermal Expansion Coefficient	<4.00 x 10 ⁻⁵ °C	1.27 x 10 ⁻⁵ °C ⁻¹
Heat Distortion Temperature	>95 °C	106 °C

Properties	Test
Standard panel sizes in mm	1220 x 2440 1220 x 3050 1220 x 3660 1220 x 4000 1500 x 3050 1500 x 3660 (other sizes available by request - subject to MOQ)
Aluminium skin thickness in mm	0.15 0.21 0.30 Aluminium Alloy 3000 series
Panel thickness in mm	2 3 4
Weight Kg per square metre	Digi-Panel Premium 4.56 Digi-Panel Sign 4.26 Digi-Panel Lite 4.08

Warranty Details

Warranty	Satin PE Surface	Gloss Surface	De-lamination
Digi Panel Premium	10 year indoor / 5 year outdoor	10 year indoor / 3 year outdoor	10 year indoor / 5 year outdoor
Digi Panel Sign	10 year indoor / 5 year outdoor	10 year indoor / 3 year outdoor	10 year indoor / 5 year outdoor
Digi Panel Lite	10 year indoor / 5 year outdoor	10 year indoor / 3 year outdoor	10 year indoor / 5 year outdoor